

Biotechnology Explorer™

pGLO™ Bacterial Transformation Kit

Catalog Number

166-0003EDU

explorer.bio-rad.com

Store components of this kit at room temperature.

Duplication of any part of this document is permitted for classroom use only.

BIO-RAD

Student Manual

pGLO Transformation

Lesson 1 Introduction to Transformation

In this lab you will perform a procedure known as genetic transformation. Remember that a gene is a piece of DNA which provides the instructions for making (codes for) a protein. This protein gives an organism a particular trait. Genetic transformation literally means change caused by genes, and involves the insertion of a gene into an organism in order to change the organism's trait. Genetic transformation is used in many areas of biotechnology. In agriculture, genes coding for traits such as frost, pest, or spoilage resistance can be genetically transformed into plants. In bioremediation, bacteria can be genetically transformed with genes enabling them to digest oil spills. In medicine, diseases caused by defective genes are beginning to be treated by gene therapy; that is, by genetically transforming a sick person's cells with healthy copies of the defective gene that causes the disease.

You will use a procedure to transform bacteria with a gene that codes for Green Fluorescent Protein (GFP). The real-life source of this gene is the bioluminescent jellyfish *Aequorea victoria*. Green Fluorescent Protein causes the jellyfish to fluoresce and glow in the dark. Following the transformation procedure, the bacteria express their newly acquired jellyfish gene and produce the fluorescent protein, which causes them to glow a brilliant green color under ultraviolet light.

In this activity, you will learn about the process of moving genes from one organism to another with the aid of a plasmid. In addition to one large chromosome, bacteria naturally contain one or more small circular pieces of DNA called plasmids. Plasmid DNA usually contains genes for one or more traits that may be beneficial to bacterial survival. In nature, bacteria can transfer plasmids back and forth allowing them to share these beneficial genes. This natural mechanism allows bacteria to adapt to new environments. The recent occurrence of bacterial resistance to antibiotics is due to the transmission of plasmids.

Bio-Rad's unique pGLO plasmid encodes the gene for GFP and a gene for resistance to the antibiotic ampicillin. pGLO also incorporates a special gene regulation system, which can be used to control expression of the fluorescent protein in transformed cells. The gene for GFP can be switched on in transformed cells by adding the sugar arabinose to the cells' nutrient medium. Selection for cells that have been transformed with pGLO DNA is accomplished by growth on antibiotic plates. Transformed cells will appear white (wild-type phenotype) on plates not containing arabinose, and fluorescent green when arabinose is included in the nutrient agar medium.

You will be provided with the tools and a protocol for performing genetic transformation.

Your task will be:

1. To do the genetic transformation.
2. To determine the degree of success in your efforts to genetically alter an organism.

Consideration 2: How Can I Tell if Cells Have Been Genetically Transformed?

Recall that the goal of genetic transformation is to change an organism's traits (phenotype). Before any change in the phenotype of an organism can be detected, a thorough examination of its natural (pre-transformation) phenotype must be made. Look at the colonies of *E. coli* on your starter plates. List all observable traits or characteristics that can be described:

The following pre-transformation observations of *E. coli* might provide baseline data to make reference to when attempting to determine if any genetic transformation has occurred.

- a) Number of colonies

 - b) Size of :
 - 1) the largest colony
 - 2) the smallest colony
 - 3) the majority of colonies

 - c) Color of the colonies

 - d) Distribution of the colonies on the plate

 - e) Visible appearance when viewed with ultraviolet (UV) light

 - f) The ability of the cells to live and reproduce in the presence of an antibiotic such as ampicillin
-
1. Describe how you could use two LB/agar plates, some *E. coli* and some ampicillin to determine how *E. coli* cells are affected by ampicillin.

 2. What would you expect your experimental results to indicate about the effect of ampicillin on the *E. coli* cells?

Consideration 3: The Genes

Genetic transformation involves the insertion of some new DNA into the *E. coli* cells. In addition to one large chromosome, bacteria often contain one or more small circular pieces of DNA called plasmids. Plasmid DNA usually contains genes for more than one trait. Scientists can use a process called genetic engineering to insert genes coding for new traits into a plasmid. In this case, the pGLO plasmid carries the GFP gene that codes for the green fluorescent protein and a gene (*bla*) that codes for a protein that gives the bacteria resistance to an antibiotic. The genetically engineered plasmid can then be used to genetically transform bacteria to give them this new trait.

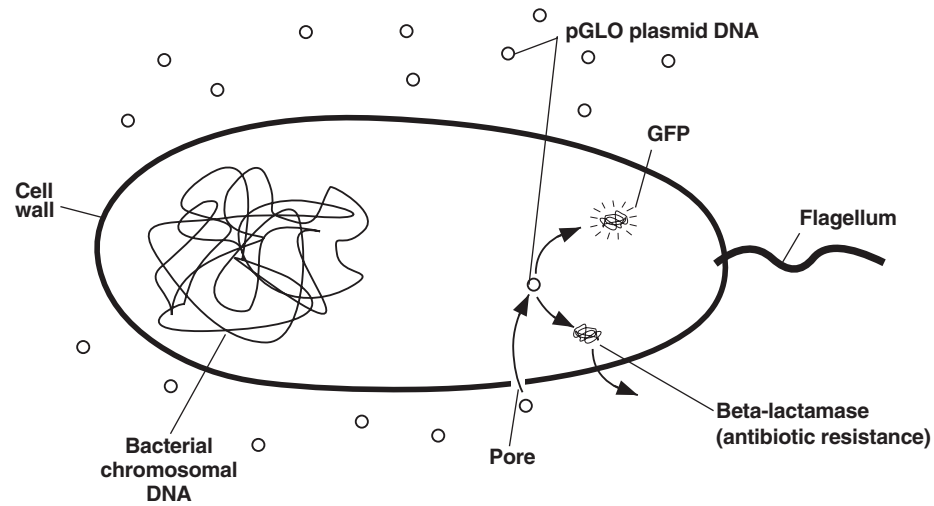

Consideration 4: The Act of Transformation

This transformation procedure involves three main steps. These steps are intended to introduce the plasmid DNA into the *E. coli* cells and provide an environment for the cells to express their newly acquired genes.

To move the pGLO plasmid DNA through the cell membrane you will:

1. Use a transformation solution of CaCl_2 (calcium chloride)
2. Carry out a procedure referred to as heat shock

For transformed cells to grow in the presence of ampicillin you must:

3. Provide them with nutrients and a short incubation period to begin expressing their newly acquired genes

Lesson 2 Transformation Laboratory

Workstation Check (✓) List

Your workstation: Materials and supplies that should be present at your workstation prior to beginning this lab are listed below.

Student workstations	Number required	(✓)
<i>E. coli</i> starter plate	1	<input type="checkbox"/>
Poured agar plates (1 LB, 2 LB/amp, 1 LB/amp/ara)	4	<input type="checkbox"/>
Transformation solution	1	<input type="checkbox"/>
LB nutrient broth	1	<input type="checkbox"/>
Inoculation loops	7 (1 pk of 10)	<input type="checkbox"/>
Pipets	5	<input type="checkbox"/>
Foam microtube holder/float	1	<input type="checkbox"/>
Container full of crushed ice (foam cup)	1	<input type="checkbox"/>
Marking pen	1	<input type="checkbox"/>
Copy of Quick Guide	1	<input type="checkbox"/>

Instructor's (common) workstation. A list of materials, supplies and equipment that should be present at a common location to be accessed by your team is also listed below.

Rehydrated pGLO plasmid	1 vial	<input type="checkbox"/>
42°C water bath and thermometer	1	<input type="checkbox"/>
37°C incubator (optional, see General Laboratory Skills–Incubation)	1	<input type="checkbox"/>

Transformation Procedure

1. Label one closed micro test tube **+pGLO** and another **-pGLO**. Label both tubes with your group's name. Place them in the foam tube rack.



2. Open the tubes and, using a sterile transfer pipet, transfer 250 μl of transformation solution (CaCl_2) into each tube.

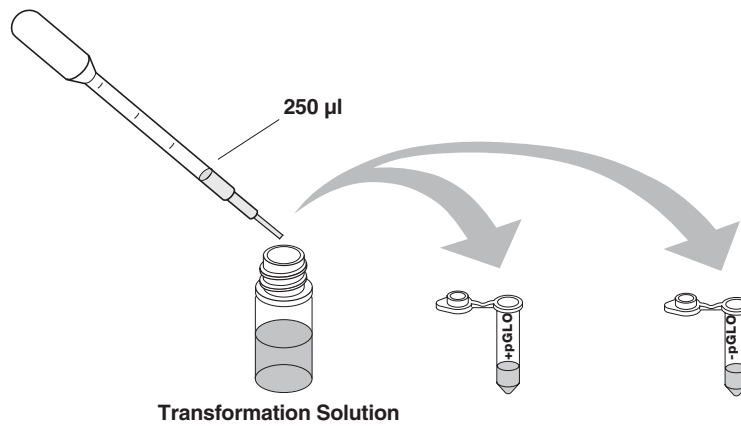

3. Place the tubes on ice.

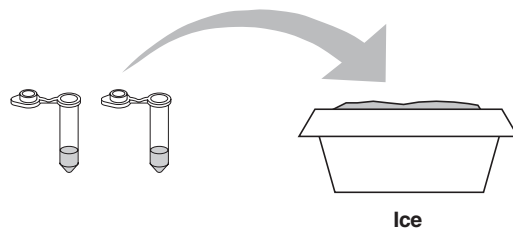

4. Use a sterile loop to pick up a **single colony of bacteria** from your starter plate. Pick up the **+pGLO** tube and immerse the loop into the transformation solution at the bottom of the tube. Spin the loop between your index finger and thumb until the entire colony is dispersed in the transformation solution (with no floating chunks). Place the tube back in the tube rack in the ice. Using a new sterile loop, repeat for the **-pGLO** tube.

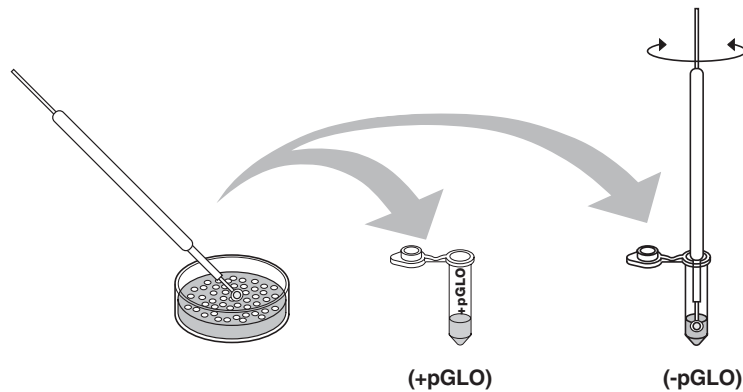

5. Examine the pGLO DNA solution with the UV lamp. Note your observations. Immerse a **new sterile loop** into the pGLO plasmid DNA stock tube. Withdraw a loopful. There should be a film of plasmid solution across the ring. This is similar to seeing a soapy film across a ring for blowing soap bubbles. Mix the loopful into the cell suspension of the **+pGLO** tube. Close the tube and return it to the rack on ice. Also close the **-pGLO** tube. **Do not** add plasmid DNA to the **-pGLO** tube. Why not?

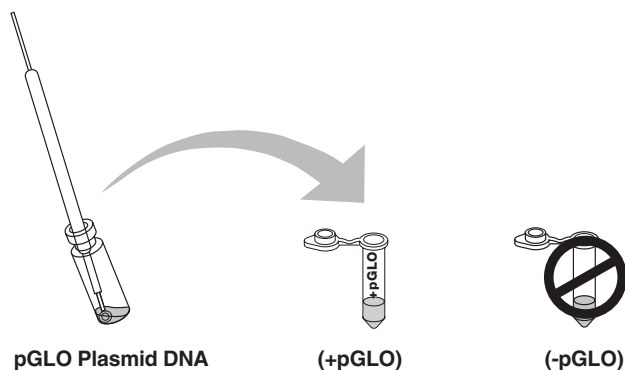

6. Incubate the tubes on ice for 10 minutes. Make sure to push the tubes all the way down in the rack so the bottom of the tubes stick out and make contact with the ice.

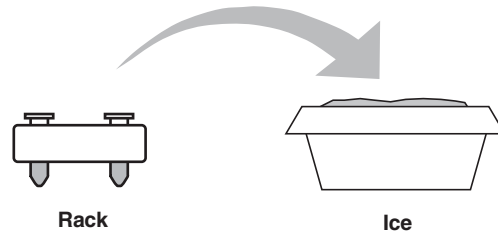

7. While the tubes are sitting on ice, label your four LB nutrient agar plates on the bottom (not the lid) as follows:

- Label one **LB/amp** plate: + pGLO
- Label the **LB/amp/ara** plate: + pGLO
- Label the other **LB/amp** plate: - pGLO
- Label the **LB** plate: - pGLO



8. **Heat shock.** Using the foam rack as a holder, transfer both the (+) pGLO and (-) pGLO tubes into the water bath, set at 42°C, for exactly 50 seconds. Make sure to push the tubes all the way down in the rack so the bottom of the tubes stick out and make contact with the warm water.

When the 50 seconds are done, place both tubes back on ice. For the best transformation results, the transfer from the ice (0°C) to 42°C and then back to the ice must be rapid. Incubate tubes on ice for 2 minutes.

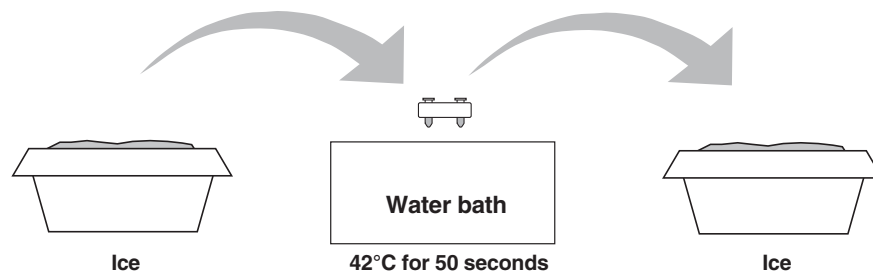

9. Remove the rack containing the tubes from the ice and place on the bench top. Open a tube and, using a new sterile pipet, add 250 μ l of LB nutrient broth to the tube and reclose it. Repeat with a new sterile pipet for the other tube. Incubate the tubes for 10 minutes at room temperature.

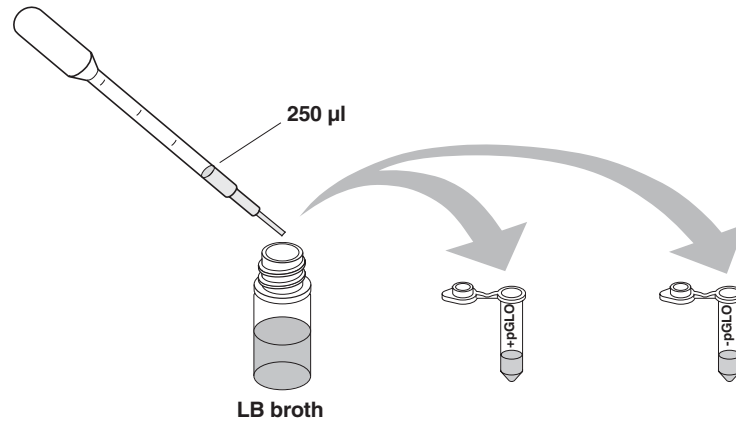

10. Tap the closed tubes with your finger to mix. Using a new sterile pipet for each tube, pipet 100 μ l of the transformation and control suspensions onto the appropriate nutrient agar plates.

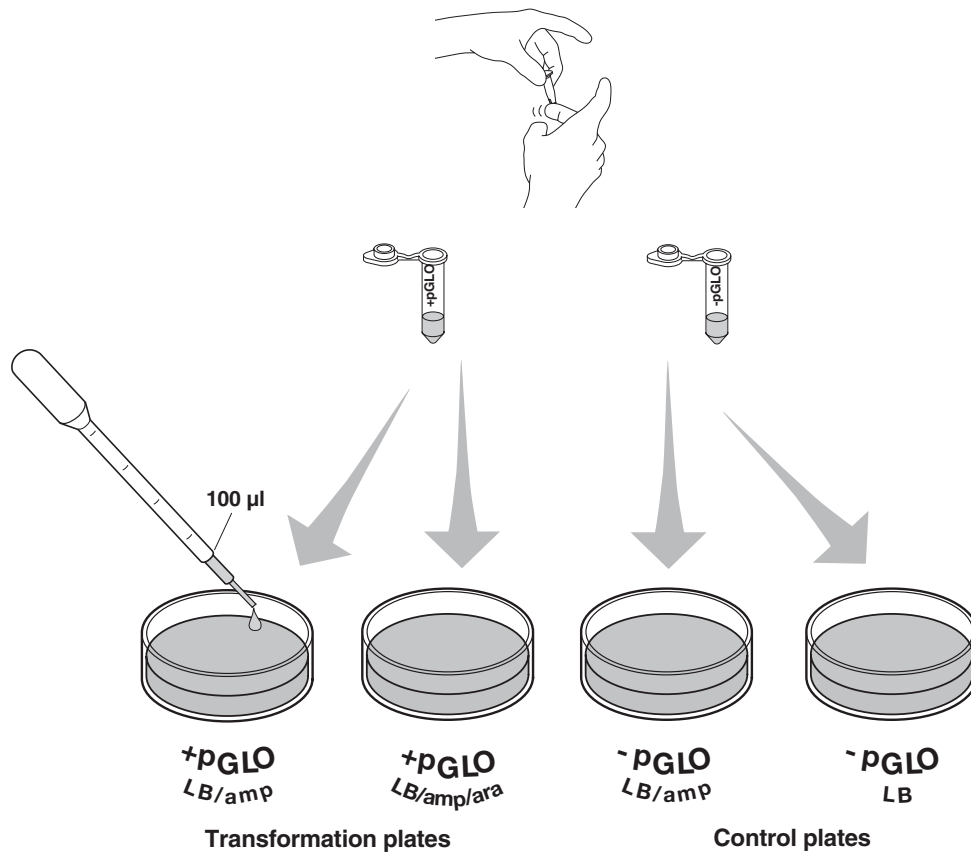

11. Use a new sterile loop for each plate. Spread the suspensions evenly around the surface of the LB nutrient agar by quickly skating the flat surface of a new sterile loop back and forth across the plate surface. DO NOT PRESS TOO DEEP INTO THE AGAR.

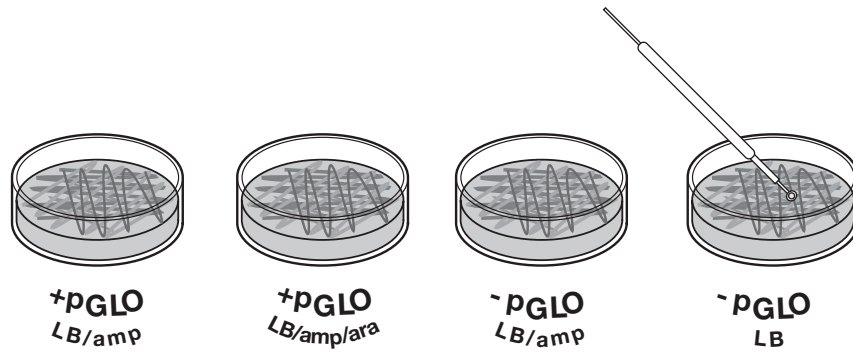

12. Stack up your plates and tape them together. Put your group name and class period on the bottom of the stack and place the stack of plates **upside down** in the 37°C incubator until the next day.

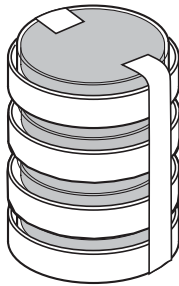

Lesson 3 Data Collection and Analysis

A. Data Collection

Observe the results you obtained from the transformation lab under normal room lighting. Then turn out the lights and hold the ultraviolet light over the plates.

1. Carefully observe and draw what you see on each of the four plates. Put your drawings in the data table in the column on the right. Record your data to allow you to compare observations of the “+ pGLO” cells with your observations for the non-transformed *E. coli*. Write down the following observations for each plate.
2. How much bacterial growth do you see on each plate, relatively speaking?
3. What color are the bacteria?
4. How many bacterial colonies are on each plate (count the spots you see).

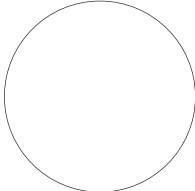
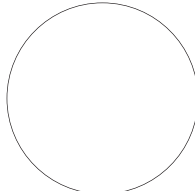
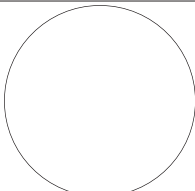
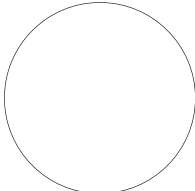
		Observations
Transformation plates	+pGLO LB/amp	
	+pGLO LB/amp/ara	
Control plates	-pGLO LB/amp	
	-pGLO LB	

B. Analysis of Results

The goal of data analysis for this investigation is to determine if genetic transformation has occurred.

1. Which of the traits that you originally observed for *E. coli* did not seem to become altered? In the space below list these untransformed traits and how you arrived at this analysis for each trait listed.

Original trait

Analysis of observations

2. Of the *E. coli* traits you originally noted, which seem now to be significantly different after performing the transformation procedure? List those traits below and describe the changes that you observed.

New trait

Observed change

3. If the genetically transformed cells have acquired the ability to live in the presence of the antibiotic ampicillin, then what might be inferred about the other genes on the plasmid that you used in your transformation procedure?

4. From the results that you obtained, how could you prove that the changes that occurred were due to the procedure that you performed?

Lesson 3 Review Questions **Name** _____

What's Glowing?

If a fluorescent green color is observed in the *E. coli* colonies then a new question might well be raised, "What are the two possible sources of fluorescence within the colonies when exposed to UV light?"

Explain:

1. Recall what you observed when you shined the UV light onto a sample of original pGLO plasmid DNA and describe your observations.
2. Which of the two possible sources of the fluorescence can now be eliminated?
3. What does this observation indicate about the source of the fluorescence?
4. Describe the evidence that indicates whether your attempt at performing a genetic transformation was successful or not successful.

Lesson 3 Review Questions **Name** _____

The Interaction between Genes and Environment

Look again at your four plates. Do you observe some *E. coli* growing on the LB plate that does not contain ampicillin or arabinose?

1. From your results, can you tell if these bacteria are ampicillin resistant by looking at them on the LB plate? Explain your answer.

2. How would you change the bacteria's environment—the plate they are growing on—to best tell if they are ampicillin resistant?

3. Very often an organism's traits are caused by a combination of its genes and its environment. Think about the green color you saw in the genetically transformed bacteria:
 - a. What two factors must be present in the bacteria's environment for you to see the green color? (Hint: one factor is in the plate and the other factor is in how you look at the bacteria).

 - b. What do you think each of the two environmental factors you listed above are doing to cause the genetically transformed bacteria to turn green?

 - c. What advantage would there be for an organism to be able to turn on or off particular genes in response to certain conditions?

Lesson 4 Extension Activity: Calculate Transformation Efficiency

Your next task in this investigation will be to learn how to determine the extent to which you genetically transformed *E. coli* cells. This quantitative measurement is referred to as the transformation efficiency.

In many experiments, it is important to genetically transform as many cells as possible. For example, in some types of gene therapy, cells are collected from the patient, transformed in the laboratory, and then put back into the patient. The more cells that are transformed to produce the needed protein, the more likely that the therapy will work. The transformation efficiency is calculated to help scientists determine how well the transformation is working.

The Task

You are about to calculate the transformation efficiency, which gives you an indication of how effective you were in getting DNA molecules into bacterial cells. Transformation efficiency is a number. It represents the total number of bacterial cells that express the green protein, divided by the amount of DNA used in the experiment. (It tells us the total number of bacterial cells transformed by one microgram of DNA.) The transformation efficiency is calculated using the following formula:

$$\text{Transformation efficiency} = \frac{\text{Total number of cells growing on the agar plate}}{\text{Amount of DNA spread on the agar plate (in } \mu\text{g)}}$$

Therefore, before you can calculate the efficiency of your transformation, you will need two pieces of information:

- (1) **The total number of green fluorescent colonies growing on your LB/amp/ara plate.**
- (2) **The total amount of pGLO plasmid DNA in the bacterial cells spread on the LB/amp/ara plate.**

1. Determining the Total Number of Green Fluorescent Cells

Place your LB/amp/ara plate near a UV light. Each colony on the plate can be assumed to be derived from a single cell. As individual cells reproduce, more and more cells are formed and develop into what is termed a colony. The most direct way to determine the **total number of green fluorescent cells** is to count the colonies on the plate.

Enter that number here ⇒

Total number of cells = _____

2. Determining the Amount of pGLO DNA in the Bacterial Cells Spread on the LB/amp/ara Plate

We need two pieces of information to find out the amount of pGLO DNA in the bacterial cells spread on the LB/amp/ara plate in this experiment. (a) What was the total amount of DNA we began the experiment with, and (b) What fraction of the DNA (in the bacteria) actually got spread onto the LB/amp/ara plates.

Once you calculate this data, you will need to multiply the **total amount of pGLO DNA** used in this experiment by the **fraction of DNA** you spread on the LB/amp/ara plate. The answer to this multiplication will tell you the amount of pGLO DNA in the bacterial cells that were spread on the LB/amp/ara plate.

a. Determining the Total Amount of pGLO plasmid DNA

The total amount of DNA we began with is equal to the product of the concentration and the total volume used, or

$$(\text{DNA in } \mu\text{g}) = (\text{concentration of DNA in } \mu\text{g}/\mu\text{l}) \times (\text{volume of DNA in } \mu\text{l})$$

In this experiment you used 10 μl of pGLO at concentration of 0.08 $\mu\text{g}/\mu\text{l}$. This means that each microliter of solution contained 0.08 μg of pGLO DNA. Calculate the **total amount of DNA** used in this experiment.

Enter that number here ⇒

Total amount of pGLO DNA (μg) used in this experiment = _____

How will you use this piece of information?

- b. **Determining the fraction of pGLO plasmid DNA (in the bacteria) that actually got spread onto the LB/amp/ara plate:** Since not all the DNA you added to the bacterial cells will be transferred to the agar plate, you need to find out what fraction of the DNA was actually spread onto the LB/amp/ara plate. To do this, divide the volume of DNA you spread on the LB/amp/ara plate by the total volume of liquid in the test tube containing the DNA. A formula for this statement is

$$\text{Fraction of DNA used} = \frac{\text{Volume spread on LB/amp plate } (\mu\text{l})}{\text{Total sample volume in test tube } (\mu\text{l})}$$

You spread 100 μl of cells containing DNA from a test tube containing a total volume of 510 μl of solution. Do you remember why there is 510 μl total solution? Look in the laboratory procedure and locate all the steps where you added liquid to the reaction tube. Add the volumes.

Use the above formula to calculate the **fraction of pGLO plasmid DNA** you spread on the LB/amp/ara plate.

Enter that number here \Rightarrow

Fraction of DNA = _____

- How will you use this piece of information?

So, how many micrograms of pGLO DNA did you spread on the LB/amp/ara plates?

To answer this question, you will need to multiply the **total amount of pGLO DNA used** in this experiment by the **fraction of pGLO DNA** you spread on the LB/amp/ara plate.

$$\text{pGLO DNA spread in } \mu\text{g} = \text{Total amount of DNA used in } \mu\text{g} \times \text{fraction of DNA used}$$

Enter that number here \Rightarrow

pGLO DNA spread (μg) = _____
--

- What will this number tell you?

Look at all your calculations above. Decide which of the numbers you calculated belong in the table below. Fill in the following table.

Number of colonies on LB/amp/ara plate =	
Micrograms of pGLO DNA spread on the plates	

Now use the data in the table to calculate the efficiency of the pGLO transformation

$$\text{Transformation efficiency} = \frac{\text{Total number of cells growing on the agar plate}}{\text{Amount of DNA spread on the agar plate}}$$

Enter that number here ⇒

Transformation efficiency = _____ transformants/μg

Analysis

Transformation efficiency calculations result in very large numbers. Scientists often use a mathematical shorthand referred to as scientific notation. For example, if the calculated transformation efficiency is 1,000 bacteria/μg of DNA, they often report this number as:

10³ transformants/μg (10³ is another way of saying 10 x 10 x 10 or 1,000)

- How would scientists report 10,000 transformants/μg in scientific notation?

Carrying this idea a little farther, suppose scientists calculated an efficiency of 5,000 bacteria/μg of DNA. This would be reported as:

5 x 10³ transformants/μg (5 times 1,000)

- How would scientists report 40,000 transformants/μg in scientific notation?

One final example: If 2,600 transformants/ μg were calculated, then the scientific notation for this number would be:

2.6×10^3 transformants/ μg (2.6 times 1,000)

Similarly:

$5,600 = 5.6 \times 10^3$ $271,000 = 2.71 \times 10^5$ $2,420,000 = 2.42 \times 10^6$

- How would scientists report 960,000 transformants/ μg in scientific notation?

- Report your calculated transformation efficiency in scientific notation.

- Use a sentence or two to explain what your calculation of transformation efficiency means.

Biotechnologists are in general agreement that the transformation protocol that you have just completed generally has a transformation efficiency of between 8.0×10^2 and 7.0×10^3 transformants per microgram of DNA.

- How does your transformation efficiency compare with the above?
- In the table below, report the transformation efficiency of several of the teams in the class.

Team	Efficiency

- How does your transformation efficiency compare with theirs?

- Calculate the transformation efficiency of the following experiment using the information and the results listed below.

DNA plasmid concentration: 0.08 $\mu\text{g}/\mu\text{l}$

250 μl CaCl_2 transformation solution

10 μl pGLO plasmid solution

250 μl LB broth

100 μl cells spread on agar

227 colonies of transformants

Fill in the following chart and show your calculations to your teacher:

Number of colonies on LB/amp/ara plate =
Micrograms of DNA spread on the plates =
Transformation efficiency =

- Extra Credit Challenge:

If a particular experiment were known to have a transformation efficiency of 3×10^3 bacteria/ μg of DNA, how many transformant colonies would be expected to grow on the LB/amp/ara plate? You can assume that the concentration of DNA and fraction of cells spread on the LB agar are the same as that of the pGLO laboratory.

Appendix A Historical Links to Biotechnology

Biological transformation has had an interesting history. In 1928, Frederick Griffith, a London physician working in a pathology laboratory, conducted an experiment that he would never be able to fully interpret as long as he lived. Griffith permanently changed (transformed) a safe, nonpathogenic bacterial strain of pneumococcus into a deadly pathogenic strain. He accomplished this amazing change in the bacteria by treating the safe bacteria with heat-killed deadly bacteria. In this mixture of the two bacterial strains there were no living, virulent bacteria, but the mixture killed the mice it was injected into. He repeated the experiment many times, always with the same results. He and many of his colleagues were very perplexed. What transformed safe bacteria into the deadly killers? Many years later, this would come to be known as the first recorded case of biological transformation conducted in a laboratory, and no one could explain it. Griffith did not know of DNA, but knew the transformation was inheritable. As any single point in history can be, Griffith's experiments in transformation can be seen as the birth of analytical genetic manipulation that has led to recombinant DNA and biotechnology, and the prospects for human gene manipulation.

In 1944, sixteen years after Griffith's experiment, a research group at Rockefeller Institute, led by Oswald T. Avery, published a paper that came directly from the work of Griffith. "What is the substance responsible?" Avery would ask his coworkers. Working with the same strains of pneumonia-causing bacteria, Avery and his coworkers provided a rigorous answer to that question. They proved that the substance is DNA, and that biological transformation is produced when cells take up and express foreign DNA. Although it took many years for credit to be given to Avery, today he is universally acknowledged for this fundamental advance in biological knowledge. Building upon the work of Avery and others, Douglas Hanahan developed the technique of colony transformation used in this investigation.^{1,2}

Historical Context

Genetic Transformation

1865—Gregor Johann Mendel: Mendel presented his findings describing the principles by which genetic traits are passed from parent to offspring. From his work the concept of the gene as the basic unit of heredity was derived.

1900—Carl Correns, Hugo De Vries, Erich Tschermak: Plant geneticists conducting inheritance studies uncovered that their work was essentially a duplicate of work performed nearly four decades earlier by an unknown Austrian Augustinian monk, Gregor Johann Mendel, who studied peas.

1928—Frederick Griffith: Griffith transformed nonpathogenic *Diplococcus pneumonia* into pathogenic bacteria using heat-killed virulent bacteria. He suggested that the transforming factor had something to do with the polysaccharide capsule synthesis. Griffith did not know of DNA, but knew the transformation was inheritable. Griffith's experiments in transformation can be seen as the birth of analytical genetic manipulation that has led to recombinant DNA technology and the prospects for human gene manipulation.

1944—Oswald Avery, Colin MacLeod: Avery and his colleagues announced that they had isolated the transforming factor to a high purity, and it was DNA. Since this classic experiment in molecular genetics, transformation, conjugation (bacterial mating), and transduction (viral DNA transfer) have been used to transfer genes between species of bacteria, *Drosophila*, mice, plants and animals, mammalian cells in culture, and for human gene therapy.

- 1952—Alfred Hershey, Martha Chase: Hershey and Chase used radioisotopes of sulfur and phosphorus, and bacteriophage T2 to show conclusively that DNA was the information molecule of heredity. Along with the work of Avery, MacLeod, and McCarty, the Hershey/Chase experiment sealed the understanding that DNA was the transforming material and the information molecule of heredity.
- 1972—Paul Berg, Janet Mertz: Berg used the newly discovered endonuclease enzyme, *EcoRI*, to cut SV40 DNA and bacteriophage P22 DNA, and then used terminal transferase enzyme and DNA ligase to rejoin these separate pieces into one piece of DNA. Creation of the first recombinant DNA molecule was the beginning of the age of biotechnology. The new molecule was not placed inside a mammalian cell because of concerns in the scientific community regarding genetic transfers.
- 1973—Herbert Boyer, Stanley Cohen, Annie Chang: Berg, Boyer, and Cohen used *EcoRI* to isolate an intact gene for kanamycin resistance. Boyer, Cohen, and Chang spliced the kanamycin resistance gene into an *EcoRI* cut plasmid that already contained tetracycline resistance and produced a recombinant bacterial plasmid molecule with dual antibiotic resistance. They then transformed *E. coli* with this engineered plasmid.
- 1977—Genentech, Inc.: The first product of genetic engineering, the gene for human somatostatin (human growth hormone-releasing inhibitory factor), was expressed in bacteria and announced by Genentech.
- 1980—J. W. Gordon, Frank Ruddle: Gordon and Ruddle successfully microinjected normal genes into mouse germ-line cells.
- 1982—Richard Palmiter, Ralph Brinster: Palmiter and Brinster microinjected the gene for rat growth hormone into mice embryos. This was the first genetic germ-line “cure” reported in a mammal. The recipient mouse was called “little” because it suffered from a form of congenital dwarfism.
- 1988—Steven Rosenberg: Rosenberg and his colleagues were given approval to perform the first gene transfer experiment in human patients suffering from metastatic melanoma. This experiment represented genetic tracking with the marker gene Neo^R and not gene therapy.
- 1990—W. French Anderson, Michael Blaese, Kenneth Culver: At 12:52 p.m. on Friday, September 14, 1990 at the National Cancer Institute, a four year old girl, Ashanthi De Silva from Cleveland, Ohio, became the first human gene-therapy patient. She was infused with her own white blood cells carrying the corrected version of the adenosine deaminase (ADA) gene. Drs. Anderson, Blaese and Culver did not expect meaningful results from the experiment for about 1 year. A second girl, Cynthia Cutshall, was similarly injected in 1990. Reports in June 1993 showed the two girls with smiles and childish energy, playing in a school yard. Both girls’ immune systems were working effectively.
- 1994—Other gene therapy candidates include sickle cell anemia, hemophilia, diabetes, cancer, and heart disease patients. Germ line gene therapy is debated during meeting of the Recombinant DNA Advisory Committee. By 1996 a growing number of proposals await review by the Human Gene Therapy Subcommittee of the Recombinant DNA Advisory Committee.
- 1995—Led by J. Craig Venter, a group at the institute for Genomic Research (TIGR) in Maryland, published the full gene sequence of the bacterium *Hemophilus influenzae*, a landmark in microbiological research as the first free-living organism whose genetic “blueprint” was decoded.
- 1996—A multinational collaboration including more than 100 laboratories from Europe,

USA, Canada, and Japan was the first to unravel the entire genome sequence of a eukaryote, the yeast *Saccharomyces cerevisiae*. *S. cerevisiae* is a commercially significant yeast commonly used in baking and in fermentation of alcoholic beverages and is widely used in the laboratory as a model organism for understanding cellular and molecular processes of eukaryotes.

1997—Scientists led by Ian Wilmut at Scotland’s Roslin Institute reported the successful cloning of a sheep, named Dolly, from the cell of an adult udder cell. The cloning of Dolly sparked international debate about ethical and moral issues concerning cloning. Subsequently, scientists at Scotland’s Roslin Institute, in collaboration with Scotland-based PPL Therapeutics, successfully cloned two genetically modified lambs, named Polly and Molly, that were genetically modified with a human gene so that their milk contained a protein called factor IX, a blood-clotting protein that can be extracted and used in treating human hemophilia.

1998—Over 99% of the genome sequence of the first multicellular organism, the tiny roundworm *Caenorhabditis elegans*, was reported. Although *C. elegans* is a primitive organism, it shares many of its essential genetic and biological characteristics with humans and may help scientists identify and characterize the genes involved in human biology and disease.

Scientists produced a detailed and accurate physical map, or location, for most of the 30,000 known human genes, a milestone for the Human Genome Project.

2000—A team led by Ingo Potrykus of the Swiss Federal Institute of Technology in Zurich and Peter Beyer of the University of Freiburg in Germany reported the creation of genetically modified rice called “golden rice”, which can produce large amounts of beta-carotene, a substance that human beings can turn into Vitamin A. “Golden rice” could alleviate blindness caused by vitamin A deficiency in millions of poverty-stricken people around the world.

The genome sequence of the fruit fly *Drosophila melanogaster* was published through a collaboration between a private company, Celera Genomics, and researchers worldwide studying the fruit fly. *D. melanogaster*, a model used widely in the laboratory, is the largest animal so far to have its genetic code deciphered.

A rough draft of the human genome was completed by a team of 16 international institutions that form the Human Genome Sequencing Consortium. Researchers at Celera Genomics also announced completion of their ‘first assembly’ of the genome.

2001—On February 12, 2001, Celera Genomics and the International Human Genome Sequencing Consortium jointly announced the publishing of the nearly complete sequence of the human genome - the genetic “blueprint” for a human being. This accomplishment took the international team almost twenty years and involved the collaboration of thousands of scientists from around the world. Celera Genomics reported completing the work in approximately nine months. The two groups differed in their estimates for the number of genes in the human genome, but the range predicted by both groups, between 25,000 and 40,000 genes, is far fewer than the previous estimate of 100,000 genes. This unexpected finding suggested that an organism as complex as a human being can be made of so few genes, only twice as many as found in the worm *C. elegans* or the fly *D. melanogaster*. The unveiling of the full sequence of the human genome makes it possible for researchers all over the world to begin developing treatments for many diseases.

President George Bush decided that only experiments involving the existing 64 embryonic stem cell lines would be eligible for possible federal funding. The president’s decision was disappointing to many scientists who hoped to use embryonic stem cells to develop treatments for many ailments.

Advanced Cell Technology, a small company in Massachusetts, announced that it had successfully cloned human embryos for the purpose of extracting their stem cells. This method could ultimately be used to treat patients with a variety of diseases by making replacement cells, such as nerve and muscle cells, which can be transplanted back into same person without the risk of being rejected by the body.

PPL Therapeutics, the company that helped to clone Dolly the sheep, announced that it had cloned five genetically modified piglets with an inactivated, or “knocked out”, gene that would make their organs much less likely to be rejected when transplanted into a human recipient. The success of PPL Therapeutics brings hope to the thousands of people who are waiting to receive donated organs such as hearts, lungs, kidneys, and livers.

2002—Dolly the sheep, the first mammal to be cloned from an adult cell, developed arthritis at a relatively early age of five years. It is not clear whether Dolly’s condition was the result of a genetic defect caused by cloning, or whether it was a mere coincidence. The news has renewed debates on whether cloned animals are susceptible to premature aging and health problems and has also been a setback for those who argue that cloning can be used to generate a supply of organs to help patients on the transplant list.

Appendix B Glossary of Terms

Agar	Provides a solid matrix to support bacterial growth. Contains nutrient mixture of carbohydrates, amino acids, nucleotides, salts, and vitamins.
Antibiotic Selection	Use of an antibiotic to select bacteria containing the DNA of interest. The pGLO plasmid DNA contains the gene for beta-lactamase that provides resistance to the antibiotic ampicillin. Once bacteria are transformed with the pGLO plasmid, they begin producing and secreting beta-lactamase protein. Secreted beta-lactamase breaks down ampicillin, rendering the antibiotic harmless to the bacterial host. Only bacteria containing the pGLO plasmid can grow and form colonies in nutrient medium containing ampicillin, while untransformed cells that have not taken up the pGLO plasmid cannot grow on the ampicillin selection plates.
Arabinose	A carbohydrate isolated from plants that is normally used as source of food by bacteria.
Beta-Lactamase	Beta-lactamase is a protein that provides resistance to the antibiotic ampicillin. The beta-lactamase protein is produced and secreted by bacteria that have been transformed with a plasmid containing the gene for beta-lactamase. The secreted beta-lactamase inactivates the ampicillin present in the LB nutrient agar, which allows for bacterial growth and expression of newly acquired genes also contained on the plasmid, <i>i.e.</i> , GFP.
Biotechnology	Applying biology in the real world by the specific manipulation of living organisms, especially at the genetic level, to produce potentially beneficial products.
Cloning	Cloning is the process of generating virtually endless copies or clones of an organism or segment of DNA. Cloning produces a population that has an identical genetic makeup.
Colony	A clump of genetically identical bacterial cells growing on an agar plate. Because all the cells in a single colony are genetically identical, they are called clones.
Culture Media	The liquid and solid media referred to as LB (named after Luria and Bertani) broth and agar are made from an extract of yeast and an enzymatic digest of meat byproducts which provide a mixture of carbohydrates, amino acids, nucleotides, salts, and vitamins, all of which are nutrients for bacterial growth. Agar, which is from seaweed, polymerizes when heated and cooled to form a solid gel (similar to Jell-O gelatin), and functions to provide a solid support on which to culture the bacteria.

Genetic Engineering	The manipulation of an organism's genetic material (DNA) by introducing or eliminating specific genes.
Gene Regulation	Gene expression in all organisms is carefully regulated to allow for differing conditions and to prevent wasteful overproduction of unneeded proteins. The genes involved in the transport and breakdown of food are good examples of highly regulated genes. For example, the simple sugar, arabinose, can be used as a source of energy and carbon by bacteria. The bacterial enzymes that are needed to break down or digest arabinose for food are not expressed in the absence of arabinose but are expressed when arabinose is present in the environment. In other words when arabinose is around, the genes for these digestive enzymes are turned on. When arabinose runs out these genes are turned back off. See Appendix D for a more detailed explanation of the role that arabinose plays in the regulation and expression of the Green Fluorescent Protein gene.
Green Fluorescent Protein	Green Fluorescent Protein (GFP) was originally isolated from the bioluminescent jellyfish, <i>Aequorea victoria</i> . The gene for GFP has recently been cloned. The unique three-dimensional conformation of GFP causes it to resonate when exposed to ultraviolet light and give off energy in the form of visible green light.
Plasmid	A circular DNA molecule, capable of self-replicating, carrying one or more genes for antibiotic resistance proteins and a cloned foreign gene such as GFP.
pGLO	Plasmid containing the GFP sequence and ampicillin resistance gene, which codes for beta-lactamase.
Recombinant DNA Technology	The process of cutting and recombining DNA fragments as a means to isolate genes or to alter their structure and function.
Screening	Process of identifying wanted bacteria from a bacterial library.
Sterile Technique	Minimizing the possibility of outside bacterial contamination during an experiment through observance of cleanliness and using careful laboratory techniques.
Streaking	Process of passing an inoculating loop with bacteria on it across an agar plate
Vector	An autonomously replicating DNA molecule, such as a plasmid, into which foreign DNA fragments are inserted and then propagated in a host cell.

Appendix C Basic Molecular Biology Concepts and Terminology

A study of the living world reveals that all living organisms organize themselves in some unique fashion. A detailed blueprint of this organization is passed on to offspring.

Cells are the smallest functional units capable of independent reproduction. Many bacteria, for instance, can survive as single cells. The chemical molecules within each cell are organized to perform in concert.

Cells can be grown in culture and harvested

Cells can be gathered from their natural locations and grown inside laboratory containers. Appropriate food and environment must be provided for the cells to grow. Bacteria and yeast are very easy to grow in culture. Cells taken from plants, insects and animals can also be grown, but are more difficult to care for.

After growth is complete, cells in culture can be harvested and studied.

Cloning

When a population of cells is prepared by growth from a single cell, all the cells in the population will be genetically identical. Such a population is called clonal. The process of creating a clonal population is called cloning. The purpose of streaking bacteria on agar is to generate single colonies, each arising from a single cell.

Looking inside cells

The molecules inside a cell each perform a given function. For instance, DNA molecules store information (like the hard drive in a computer). Proteins are the workhorses of the cell.

To study these molecules we prepare a clonal population from a cell type of interest, break open the cells and sort the contents. For instance, it is fairly easy to separate all the proteins from all the DNA molecules.

Purifying a single species of protein out of the mixture of proteins found inside a cell type is also possible. Each type of protein has unique physical and chemical properties. These properties allow the separation of protein species based on size, charge, or hydrophobicity, for instance.

Special molecules, specialized functions

We will take a close look at three very special kinds of molecules found inside cells: DNA, RNA and proteins. Each of these molecules performs a different function. DNA molecules are like file cabinets in which information is stored. RNA helps to retrieve and execute the instructions which are stored in DNA. Proteins are designed to perform chemical chores inside (and often outside) the cell.

DNA—The universal template for biological information

The master script for each organism is encoded within its deoxyribonucleic acid (DNA). The information within the DNA molecule/s of each cell is sufficient to initiate every function that cell will perform.

DNA molecules are very long chains composed of repeating subunits. Each subunit (nucleotide) contains one of four possible bases protruding from its side:

adenine (A)	cytosine (C)
thymine (T)	guanine (G)

Since nucleotides are joined head-to-tail, a long strand of DNA essentially consists of a chemical backbone with bases protruding along its side. The information carried by this molecule is encoded in the sequence of the bases **A**, **G**, **C**, and **T** along its length.

Some further points to note about DNA structure

1. Because the subunits of DNA chains are joined head-to-tail, the sequence is directional **GTCAA**. By convention, we write DNA sequence from the free 5' end of the backbone and work our way toward the other free end (3').

i.e. 5'...AACTG...3'

2. The protruding bases along the chain are free to form spontaneous hydrogen bonds with available bases on other DNA strands according to the following rules:

- (i) **A** pairs with **T**
- (ii) **C** pairs with **G**

Because of these rules, **A** and **T** are said to be complementary bases; **G** and **C** are also complementary.

- (iii) For two DNA strands to pair up, they must be complementary and run in opposite directions.

i.e. (5'...AGGTC...3') can pair with (5'...GACCT...3'). These two strands have complementary sequences. The double-stranded pair is written as follows:

5'...AGGTC...3'
3'...TCCAG...5'

The above molecule contains five base pairs. Indeed, in nature, DNA almost always occurs in double-stranded form, the two strands containing complementary sequences.

3. DNA molecules are typically thousands, sometimes millions of base pairs long. Sometimes the two ends of a DNA molecule are joined to form circular DNA.
4. Double-stranded DNA, in its native form, occurs as a coiled spring, or helix. Because it is two-stranded, it is often referred to as a double helix.

The architecture of DNA allows for a very simple strategy during reproduction: The two strands of each DNA molecule unwind and "unzip"; then, each strand allows a new complementary copy of itself to be made by an enzyme called DNA polymerase. This results in two daughter molecules, each double-stranded, and each identical to the parent molecule.

Proteins and RNA are the workhorses of the cell

The biochemistry of life requires hundreds of very specific and efficient chemical interactions, all happening simultaneously. The major players in these interactions are short-lived protein and RNA molecules which can work together or independently to serve a variety of functions. Like DNA, RNA and proteins are also long chains of repeating units.

RNA

RNA (ribonucleic acid), like DNA, consists of four types of building blocks strung together in a chain. It differs from DNA in the following respects:

The four bases in RNA are **A, G, C, and U** (uracil); the pairing rules are the same as for DNA except that **A** pairs with **U**. Although RNA can pair with complementary RNA or DNA, in cells RNA is usually single-stranded. The sugar in the RNA backbone is ribose, not deoxyribose. RNA molecules are generally short, compared to DNA molecules; this is because each RNA is itself a copy of a short segment from a DNA molecule. The process of copying segments of DNA into RNA is called transcription, and is performed by a protein called RNA polymerase.

Proteins

Proteins (more precisely, polypeptides) are also long, chain-like molecules but are more structurally diverse than either DNA or RNA. This is because the subunits of proteins, called amino acids, come in twenty different types. The exact sequence of amino acids along a polypeptide chain determines how that chain will fold into its three-dimensional structure. The precise three-dimensional features of this structure, in turn, determine its function.

What a protein will **do** depends on the exact **sequence** of its amino acids.

In most cases, a protein will perform a single function. Very diverse functions can be performed by proteins: Some proteins, called enzymes, act as catalysts in chemical reactions; some carry signals from one part of a cell to another—or, in the case of “hormones”, from one cell to another; some proteins (antibodies) have the task of fighting intruders; many become integral parts of the various physical structures inside cells; and still others (regulatory proteins) police various activities within cells so as to keep them within “legal” limits.

Linear code, three-dimensional consequences

DNA is the primary depot for information in living systems. As mentioned, this information is linear, *i.e.*, encoded in the sequence of **A, G, C, T** building blocks along the DNA molecule. This linear code can be passed on to offspring—because DNA can be replicated in exact copies.

Short segments of each DNA molecule are chosen for transcription at any given time. These segments are called genes. The enzyme RNA polymerase copies the entire segment, base by base, assembling an RNA molecule which contains a sequence of **A, G, C and U** exactly complementary to the DNA sequence of the transcribed gene.

In addition to providing a master template for copying RNAs, DNA also contains sequence information which tells the RNA polymerase where to start transcribing a gene (promoter) and where to stop; how many copies it should make and when; and it can even embed certain information within the RNA sequence to determine the longevity and productivity of that RNA.

There are three major classes of RNAs copied off DNA templates: messenger RNAs, or mRNAs, which relay the sequence information required for assembling proteins; transfer RNAs, or tRNAs, which work in the assembly line for proteins; and RNAs which perform structural functions. For example, ribosomal RNAs, or rRNAs, help build the scaffolding for ribosomes, the factories where proteins are assembled.

mRNAs carry the sequence information for making proteins. Ribosomes read this sequence of nucleotides, by a process called “translation”, into a sequence of amino acids. How is this accomplished? There are only four kinds of nucleotides, but twenty kinds of amino acids.

During translation, the ribosome reads 3 nucleotides at a time and assigns an amino acid to each successive triplet. **Note:** Triplets are often referred to as **codons**. Each amino

acid is then attached to the end of the growing protein chain. There are 64 possible triplets, or codons. Thus, the linear information residing in DNA is used to assemble a linear sequence of amino acids in a protein. This sequence, in turn, **will determine the way that protein will fold into a precise shape** with characteristic chemical properties.

In summary, the primary transfer of information within cells follows the order:

DNA→RNA→PROTEIN→TRAIT

Although the information itself is linear, the implications are three-dimensional. A fundamental assumption of recombinant DNA technology is that permanent and desirable changes in the functioning of living cells can be accomplished by changing the linear sequence of their DNA.

Genes are discrete files of DNA information

A gene is a segment within a DNA molecule singled out for copying into RNA. Directly or indirectly, this RNA will perform a function. It is convenient to think of a gene, therefore, as a unit of function.

Many traits, such as bacterial resistance to an antibiotic, are governed by single genes. Most traits—such as the color of a rose, or the shape of a nose—are governed by several genes acting in concert.

Genes can vary in length: Some are only a few hundred base pairs long; some can be tens of thousands of base pairs long. A DNA molecule may carry from a handful to thousands of genes. A cell, in turn, may contain one or several DNA molecules (chromosomes). Thus the number of genes in a cell can vary greatly. *E. coli*, a bacterium, contains one DNA molecule with about 5,000 genes on it. A human cell contains 46 DNA molecules carrying a total of about 100,000 genes.

All genes in a given cell are **not** copied into RNA (*i.e.* “expressed”) at the same time or at the same rate. Thus, when speaking of gene function, one refers to its expression level. This rate can be controlled by the cell, according to predetermined rules which are themselves written into the DNA.

An example: The cells in our bodies (all 100 trillion of them) each contain identical DNA molecules. Yet liver cells, for example, express only those genes required for liver function, whereas skin cells express a quite different subset of genes.

DNA can be cut into pieces with restriction enzymes

Restriction enzymes are proteins made by bacteria as a defense against foreign, invading DNA (for example, viral DNA). Each restriction enzyme recognizes a unique sequence of typically 4–6 base pairs, and will cut any DNA whenever that sequence occurs.

For example, the restriction enzyme *Bam*H I recognizes the sequence (5'..GGATCC..3') and cuts the DNA strand between the two G nucleotides in that sequence.

Restriction enzymes will cut DNA from any source, provided the recognition sequence is present. It does not matter if the DNA is of bacterial, plant or human origin.

Pieces of DNA can be joined by DNA ligase

DNA ligase is an enzyme that glues pieces of DNA together, provided the ends are-compatible.

Thus, a piece of human or frog or tomato DNA cut with *Bam*H I can be easily joined to a piece of bacterial DNA also cut with *Bam*H I. This allows the creation of recombinant DNAs, or hybrids, created by joining pieces of DNA from two different sources.

Genes can be cut out of human DNA or plant DNA, and placed inside bacteria. For example, the human gene for the hormone insulin can be put into bacteria. Under the right conditions, these bacteria can make authentic human insulin.

Plasmids are small circular pieces of DNA

Plasmids are small circular DNAs found inside some bacterial cells. They replicate their own DNA by borrowing the cells' polymerases. Thus they can persist indefinitely inside cells without doing very much work of their own.

Because of their small size, plasmid DNAs are easy to extract and purify from bacterial cells. When cut with a restriction enzyme, they can be joined to foreign DNAs—from any source—which have been cut with the same enzyme.

The resulting hybrid DNAs can be reintroduced into bacterial cells by a procedure called transformation. Now the hybrid plasmids can perpetuate themselves in the bacteria just as before except that the foreign DNA which was joined to it is also being perpetuated. The foreign DNA gets a free ride, so to speak.

Every hybrid plasmid now contains a perfect copy of the piece of foreign DNA originally joined to it. We say that foreign piece of DNA has been cloned; the plasmid which carried the foreign DNA is called a cloning vehicle or vector.

In addition to their usefulness for cloning foreign genes, plasmids sometimes carry genes of their own. Bacteria die when exposed to antibiotics. However, antibiotic-resistance genes allow bacteria to grow in the presence of an antibiotic such as ampicillin. Such genes are often found on plasmids. When foreign DNA is inserted into such plasmids, and the hybrids introduced into bacterial cells by transformation, it is easy to select those bacteria that have received the plasmid—because they have acquired the ability to grow in the presence of the antibiotic, whereas all other bacterial cells are killed.

DNA libraries

When DNA is extracted from a given cell type, it can be cut into pieces and the pieces can be cloned en masse into a population of plasmids. This process produces a population of hybrid (recombinant) DNAs. After introducing these hybrids back into cells, each transformed cell will have received and propagated one unique hybrid. Every hybrid will contain the same vector DNA but a different insert DNA.

If there are 1,000 different DNA molecules in the original mixture, 1,000 different hybrids will be formed; 1,000 different transformant cells will be recovered, each carrying one of the original 1,000 pieces of genetic information. Such a collection is called a DNA library. If the original extract came from human cells, the library is a human library.

Individual DNAs of interest can be fished out of such a library by screening the library with an appropriate probe.

Appendix D Gene Regulation

Our bodies contain thousands of different proteins which perform many different jobs. Digestive enzymes are proteins; some of the hormone signals that run through our bodies and the antibodies protecting us from disease are proteins. The information for assembling a protein is carried in our DNA. The section of DNA which contains the code for making a protein is called a gene. There are over 30,000–100,000 genes in the human genome. Each gene codes for a unique protein: one gene, one protein. The gene that codes for a digestive enzyme in your mouth is different from one that codes for an antibody or the pigment that colors your eyes.

Organisms regulate expression of their genes and ultimately the amounts and kinds of proteins present within their cells for a myriad of reasons, including developmental changes, cellular specialization, and adaptation to the environment. Gene regulation not only allows for adaptation to differing conditions, but also prevents wasteful overproduction of unneeded proteins which would put the organism at a competitive disadvantage. The genes involved in the transport and breakdown (catabolism) of food are good examples of highly regulated genes. For example, the sugar arabinose is both a source of energy and a source of carbon. *E. coli* bacteria produce three enzymes (proteins) needed to digest arabinose as a food source. The genes which code for these enzymes are not expressed when arabinose is absent, but they are expressed when arabinose is present in their environment. How is this so?

Regulation of the expression of proteins often occurs at the level of transcription from DNA into RNA. This regulation takes place at a very specific location on the DNA template, called a promoter, where RNA polymerase sits down on the DNA and begins transcription of the gene. In bacteria, groups of related genes are often clustered together and transcribed into RNA from one promoter. These clusters of genes controlled by a single promoter are called operons.

The three genes (*araB*, *araA* and *araD*) that code for three digestive enzymes involved in the breakdown of arabinose are clustered together in what is known as the arabinose operon.³ These three proteins are dependent on initiation of transcription from a single promoter, P_{BAD}. Transcription of these three genes requires the simultaneous presence of the DNA template (promoter and operon), RNA polymerase, a DNA binding protein called *araC* and arabinose. *araC* binds to the DNA at the binding site for the RNA polymerase (the beginning of the arabinose operon). When arabinose is present in the environment, bacteria take it up. Once inside, the arabinose interacts directly with *araC* which is bound to the DNA. The interaction causes *araC* to change its shape which in turn promotes (actually helps) the binding of RNA polymerase and the three genes *araB*, *A* and *D*, are transcribed. Three enzymes are produced, they break down arabinose, and eventually the arabinose runs out. In the absence of arabinose the *araC* returns to its original shape and transcription is shut off.

The DNA code of the pGLO plasmid has been engineered to incorporate aspects of the arabinose operon. Both the promoter (P_{BAD}) and the *araC* gene are present. However, the genes which code for arabinose catabolism, *araB*, *A* and *D*, have been replaced by the single gene which codes for GFP. Therefore, in the presence of arabinose, *araC* protein promotes the binding of RNA polymerase and GFP is produced. Cells fluoresce brilliant green as they produce more and more GFP. In the absence of arabinose, *araC* no longer facilitates the binding of RNA polymerase and the GFP gene is not transcribed. When GFP is not made, bacteria colonies will appear to have a wild-type (natural) phenotype—of white colonies with no fluorescence.

This is an excellent example of the central molecular framework of biology in action:
DNA→RNA→PROTEIN→TRAIT.

The Arabinose Operon

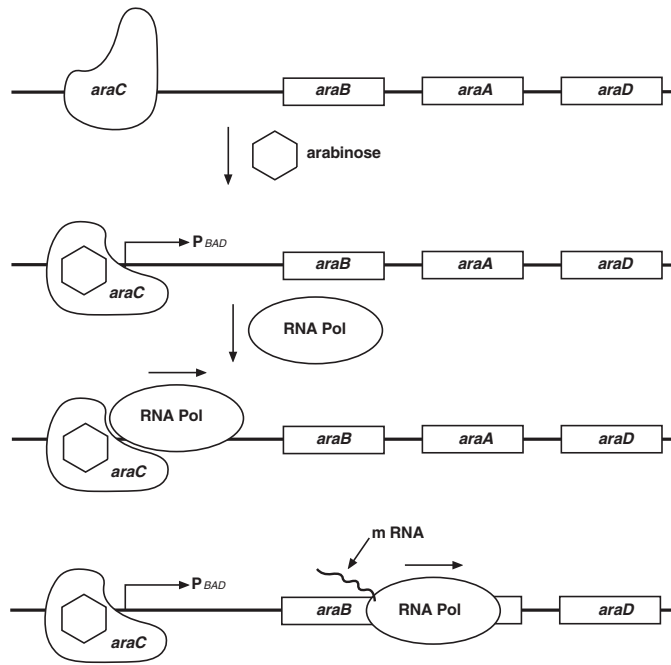

Expression of Green Fluorescent Protein

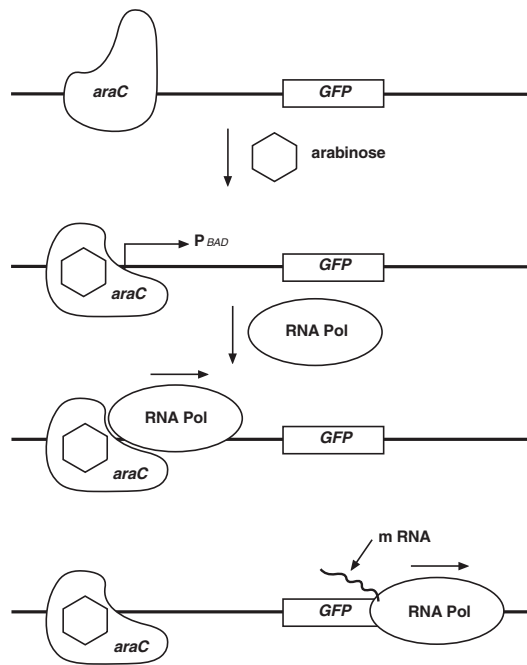

Appendix E References

1. Hanahan, Douglas, Studies on transformation of *Escherichia coli* with plasmids. *J. Mol. Biol.*, **166**, 557 (1983).
2. Hanahan, Douglas, Techniques for transformation of *E. coli*. In *DNA Cloning: A Practical Approach* (Ed. D. M. Glover), vol. 1. IRL Press, Oxford (1987).
3. Schleif, Robert, Two positively regulated systems, *ara* and *mal*, In *Escherichia coli* and *Salmonella*, Cellular and Molecular Biology, Neidhardt. ASM Press, Washington, D.C. (1996).

Parafilm is a trademark of American National Can Co.
Jell-O is a trademark of Kraft Foods, Inc.